

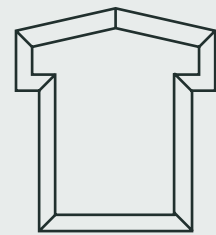

pacific place

801 MARKET STREET,
SAN FRANCISCO,
CALIFORNIA 94103

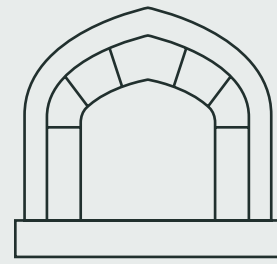
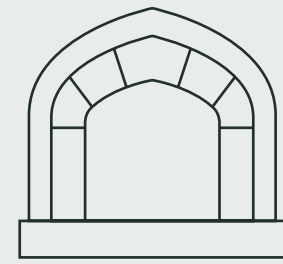
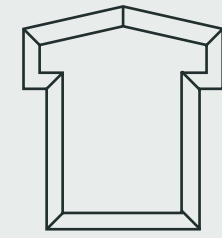

Market with an Edge

It's about choice.

At the gateway to Market Street and just **blocks away from Union Square and the Marriott Marquis**, Pacific Place is the ideal retail hub – **well served by transit**, adjacent to established **casual fashion, food and grocery** and **capturing almost 61,000 visitors to the area on a daily basis**. Pacific Place gives you more room to create, design and enhance your retail offerings, giving you scale and flexibility like no other.

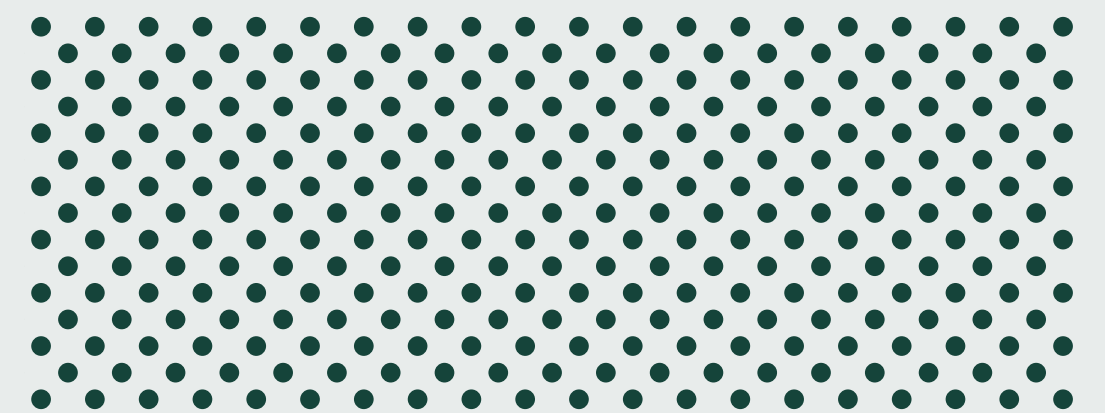
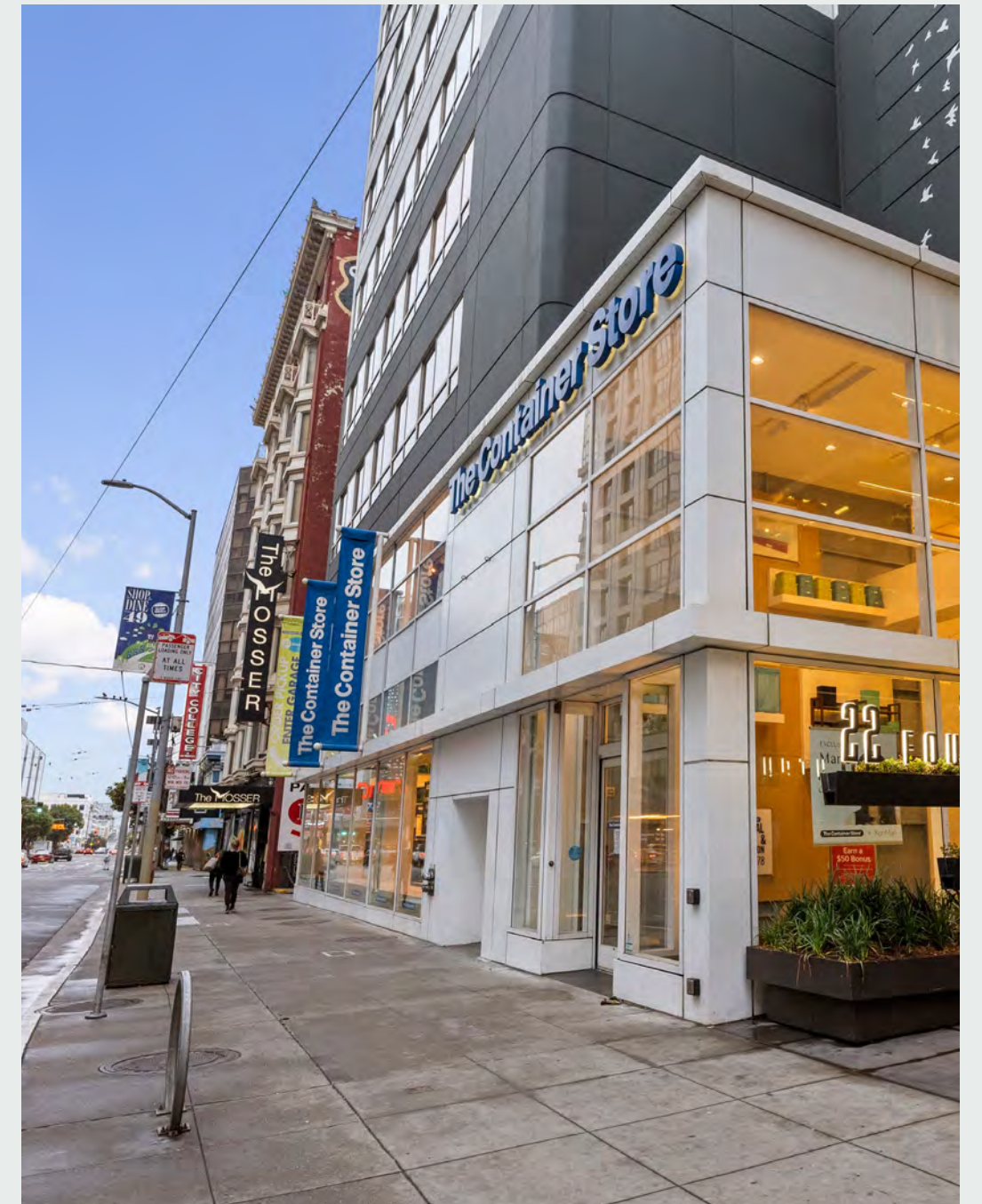

area map & notable tenants

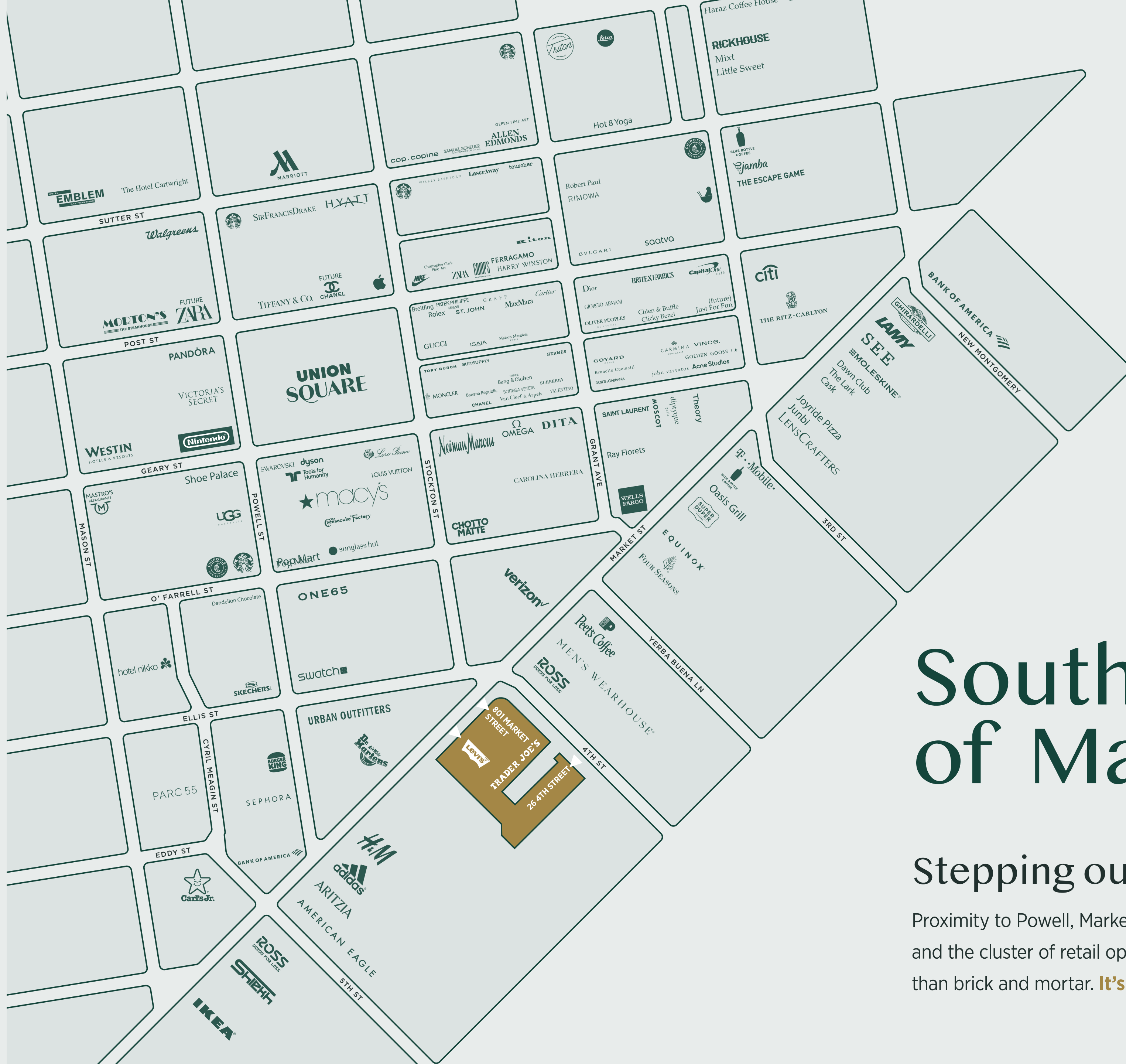

South of Market

Stepping out –

Proximity to Powell, Market and Union Square and the cluster of retail options there offers more than brick and mortar. **It's about possibilities.**

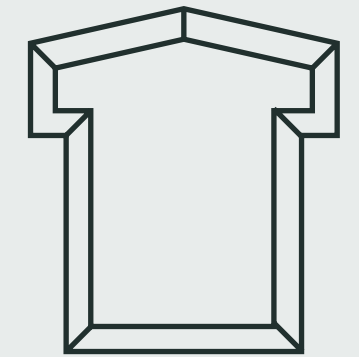

The Road to Recovery

With more than 22 million visitors to the area in 2024, Pacific Place provides visibility, access and eyeline to what people want.

PRE-COVID

FUTURE FORECAST

26.2
million

VISITORS
(2019)

23.3
million

VISITORS
(PROJECTED 2025)

\$10.2
billion

IN SPENDING

\$9.4
billion

IN SPENDING
(PROJECTED 2025)



Form Meets Function

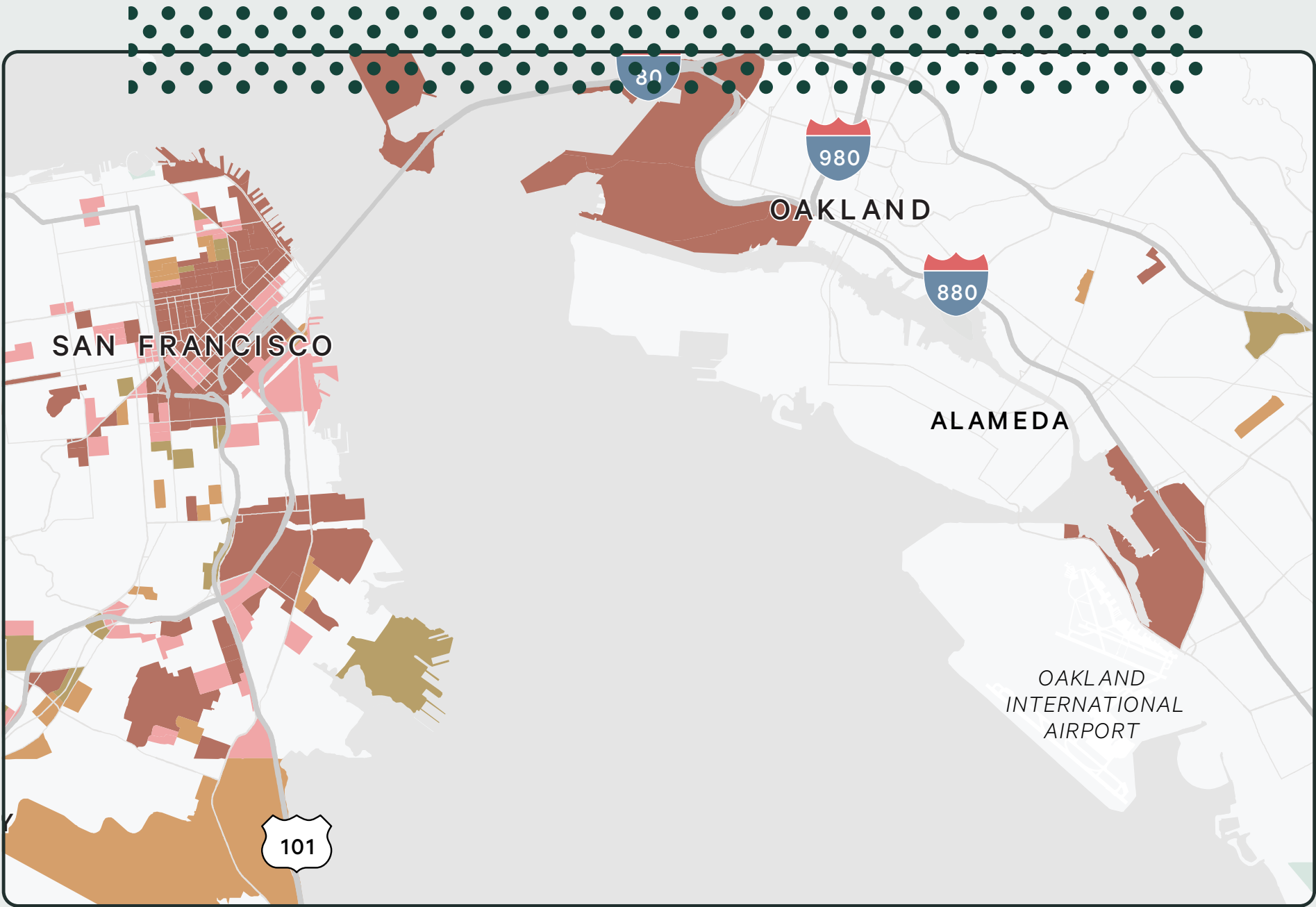

CUSTOMER PENETRATION

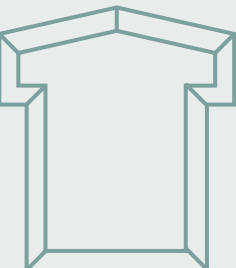
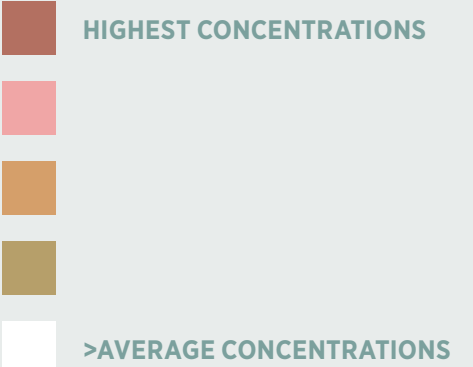

with almost 61,000 individual visits to the area daily, Pacific Place provides visibility, access and eyeline to what people want.

FOOT TRAFFIC



Market Demographics

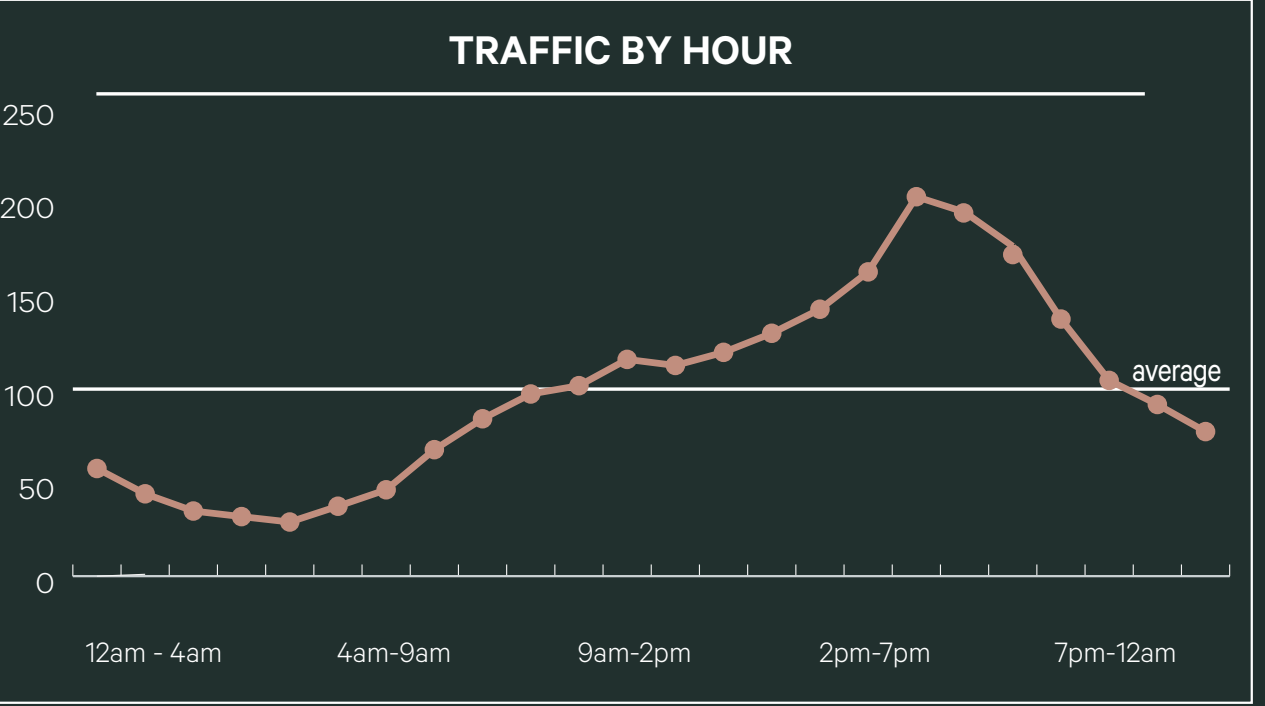
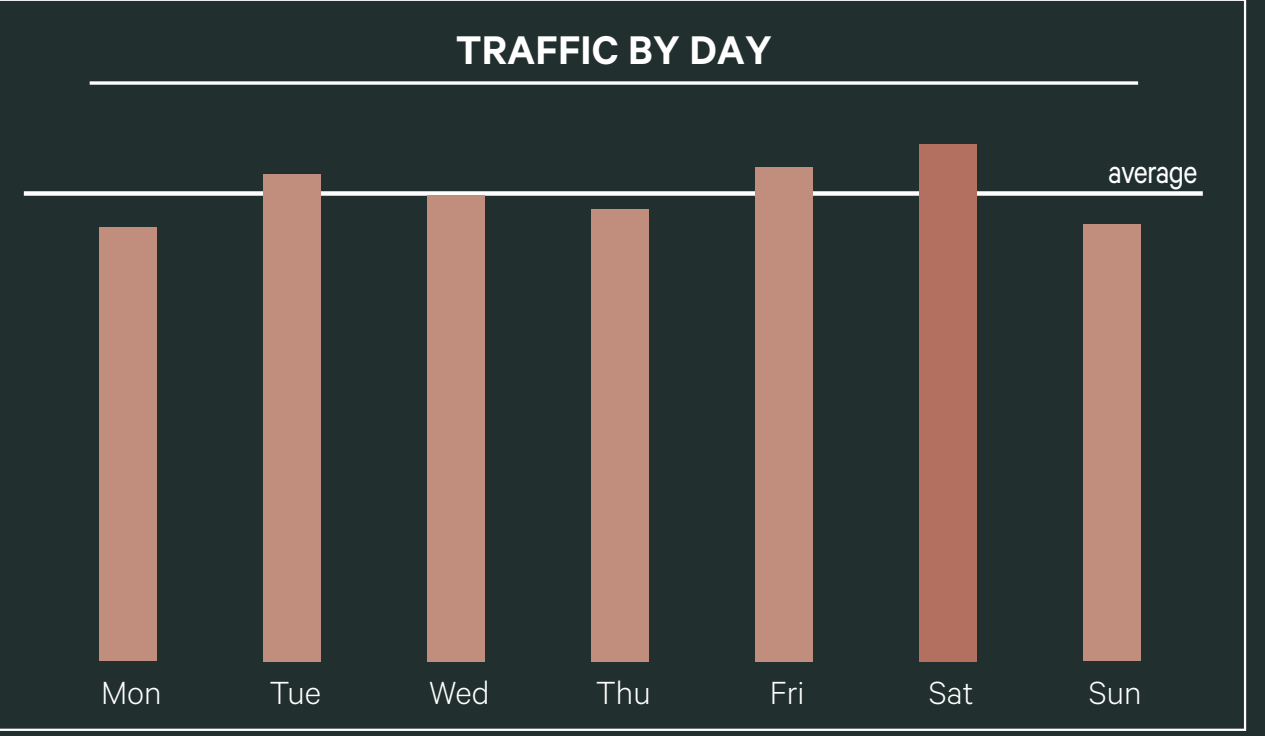
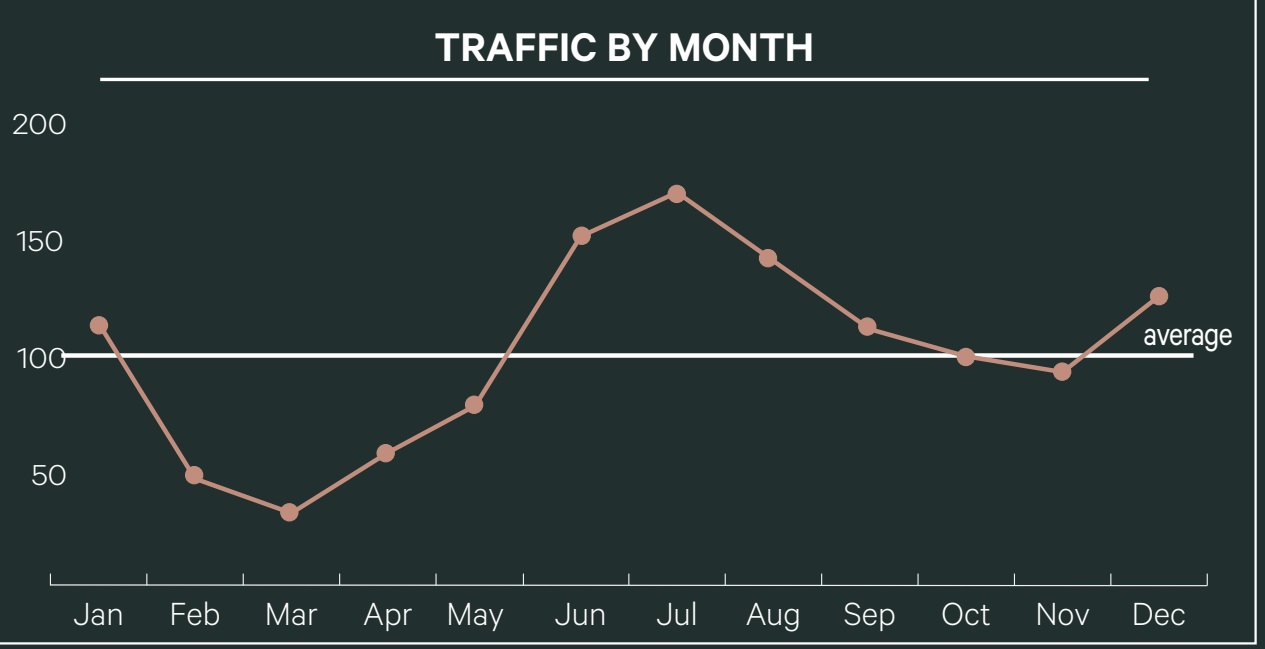

San Francisco hosted an estimated **23.1 million visitors** in 2024



Visitors to SF spent an estimated **\$9.26 billion** in 2024



San Francisco International Airport (SFO) served over **52 million passengers** in 2024, up 4.1% from 2023



Over 34,000 hotel rooms in San Francisco with a projected 64.4% occupancy rate for 2025, a 2.3% year-over-year increase from 2021



In 2024, almost 50% of the **\$17 billion venture capital funding nationally** came into the Bay Area, which drives huge spending power locally

.25 Miles

.5 Miles



7,419
hotel rooms

10,899
hotel rooms

HOTEL

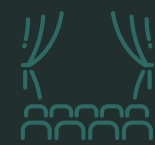

1,000+
theatre seats

9,100+
theatre seats

ENTERTAINMENT



5.9M_{SF}
of office space

34M_{SF}
of office space

OFFICE



23,466
employees

100,385
employees

DAYTIME POPULATION

Beyond Boundaries

The City Advantage



Level 1: 10,213 RSF

Total RSF: 20,564

Restrooms: Two separate restrooms located on the second floor 2 stalls/1 urinal and 3 stalls

Venting: TBC

Frontage: 64'-8" on Market Street

Ceiling heights:

Ground Floor - 10'-0" / EXPOSED @ 16'-4"

Second Floor - EXPOSED @ 14'-4"

High visibility Market Street location

Steps from Powell Street BART station

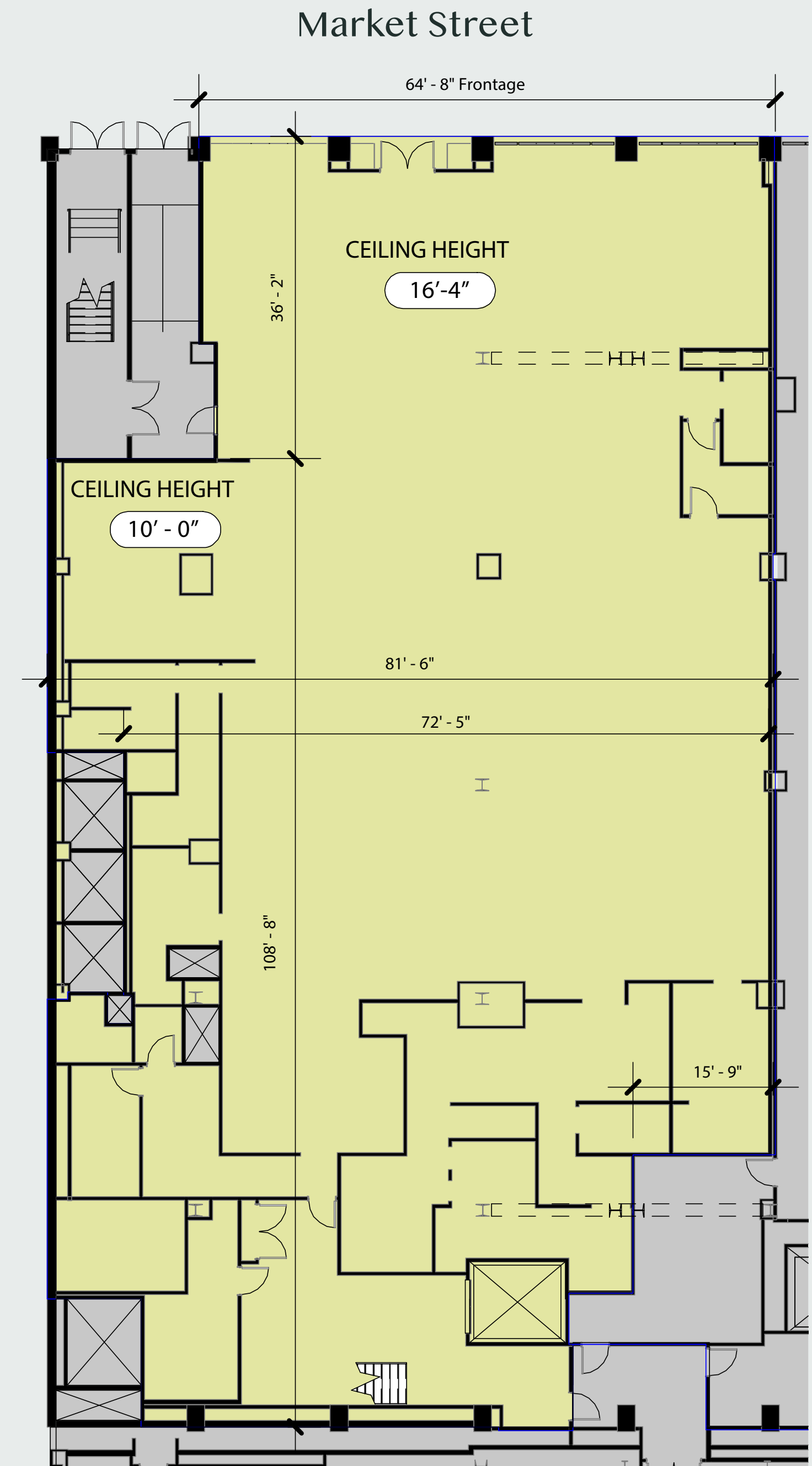
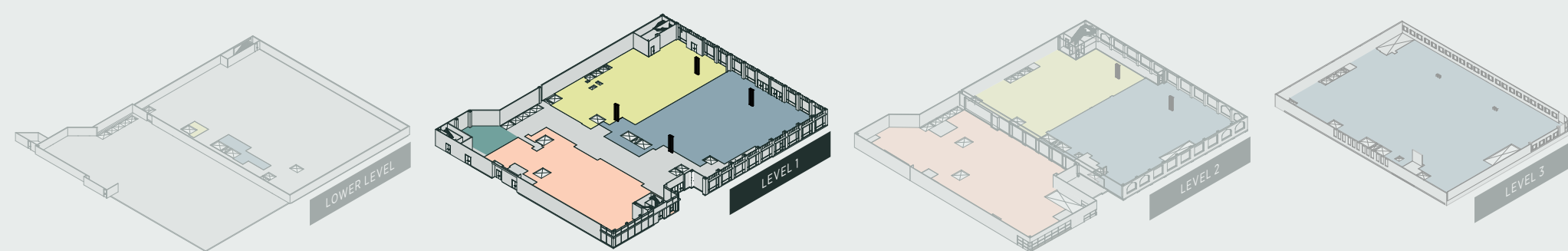

Beyond Boundaries

The City Advantage



Level 2: 10,042 RSF

Total RSF: 20,564

Restrooms: Two separate restrooms located on the second floor 2 stalls/1 urinal and 3 stalls

Venting: TBC

Frontage: 64'-8" on Market Street

Ceiling heights:

Ground Floor - 10'-0" / EXPOSED @ 16'-4"

Second Floor - EXPOSED @ 14'-4"

High visibility Market Street location

Steps from Powell Street BART station

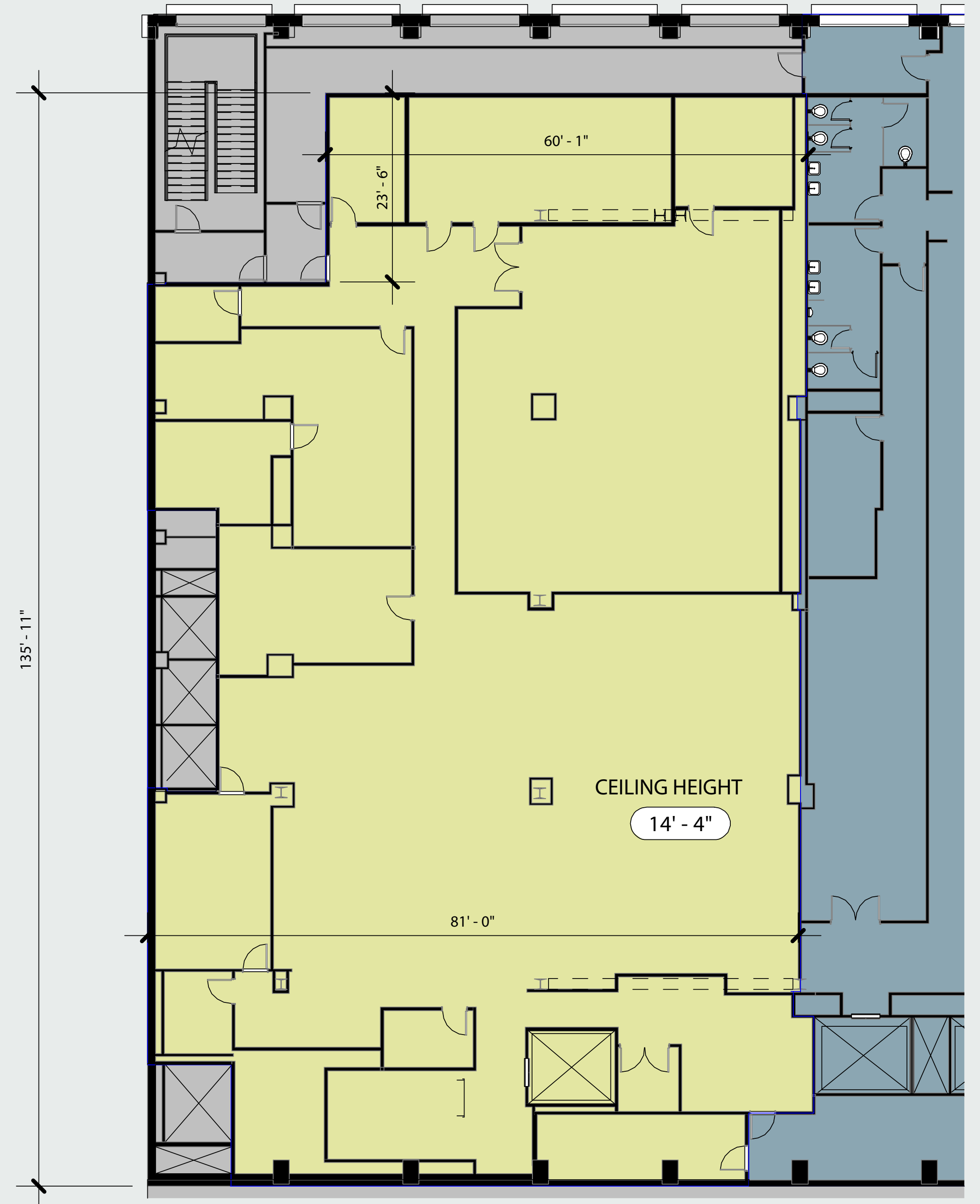
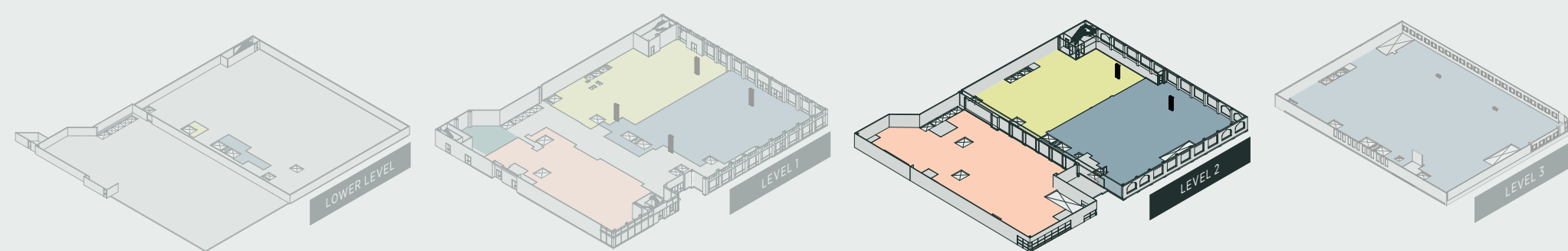

Beyond Boundaries

The City Advantage



Lower Level: 309 RSF

Total RSF: 20,564

Restrooms: Two separate restrooms located on the second floor 2 stalls/1 urinal and 3 stalls

Venting: TBC

Frontage: 64'-8" on Market Street

Ceiling heights:

Ground Floor - 10'-0" / EXPOSED @ 16'-4"

Second Floor - EXPOSED @ 14'-4"

High visibility Market Street location

Steps from Powell Street BART station

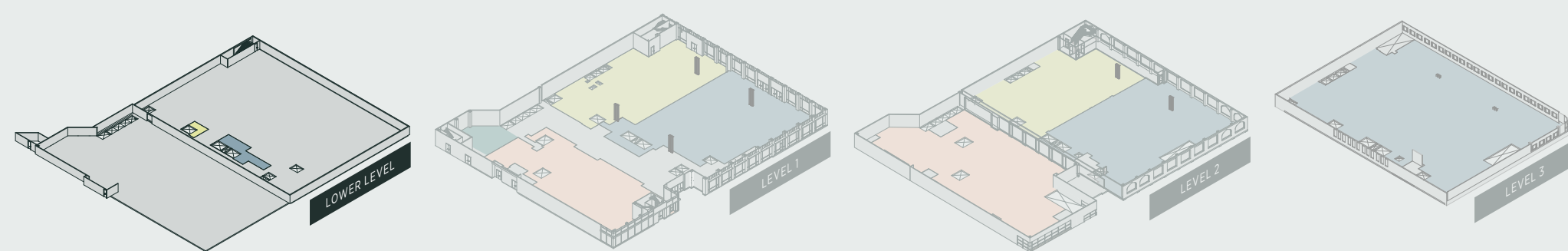
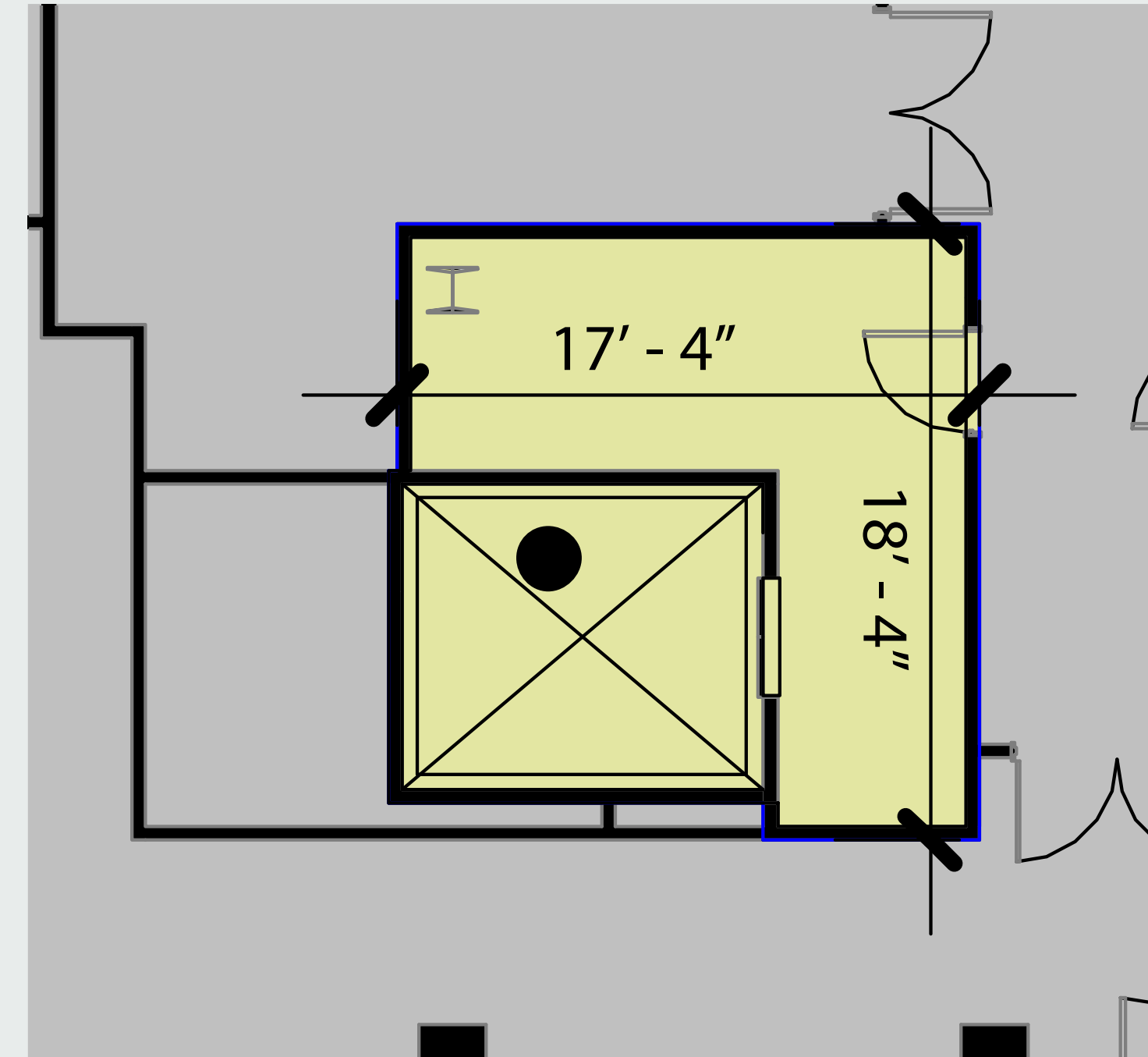

Beyond Boundaries

The City Advantage

801 Market Street | Level 1: 13,496 RSF

Total RSF: 56,838

Restrooms: Two separate restrooms located on the second level (2 stalls/1 urinal and 3 stalls)

Venting: TBC

Frontage: 113'-3" on Market Street / 65' on 4th Street

Ceiling heights:

Level 1 - EXPOSED @ 16'-4"

Level 2 - EXPOSED @ 14'-2"

Level 3 - EXPOSED @ 20'-2"

High visibility Market Street corner location

Steps from Powell Street BART station

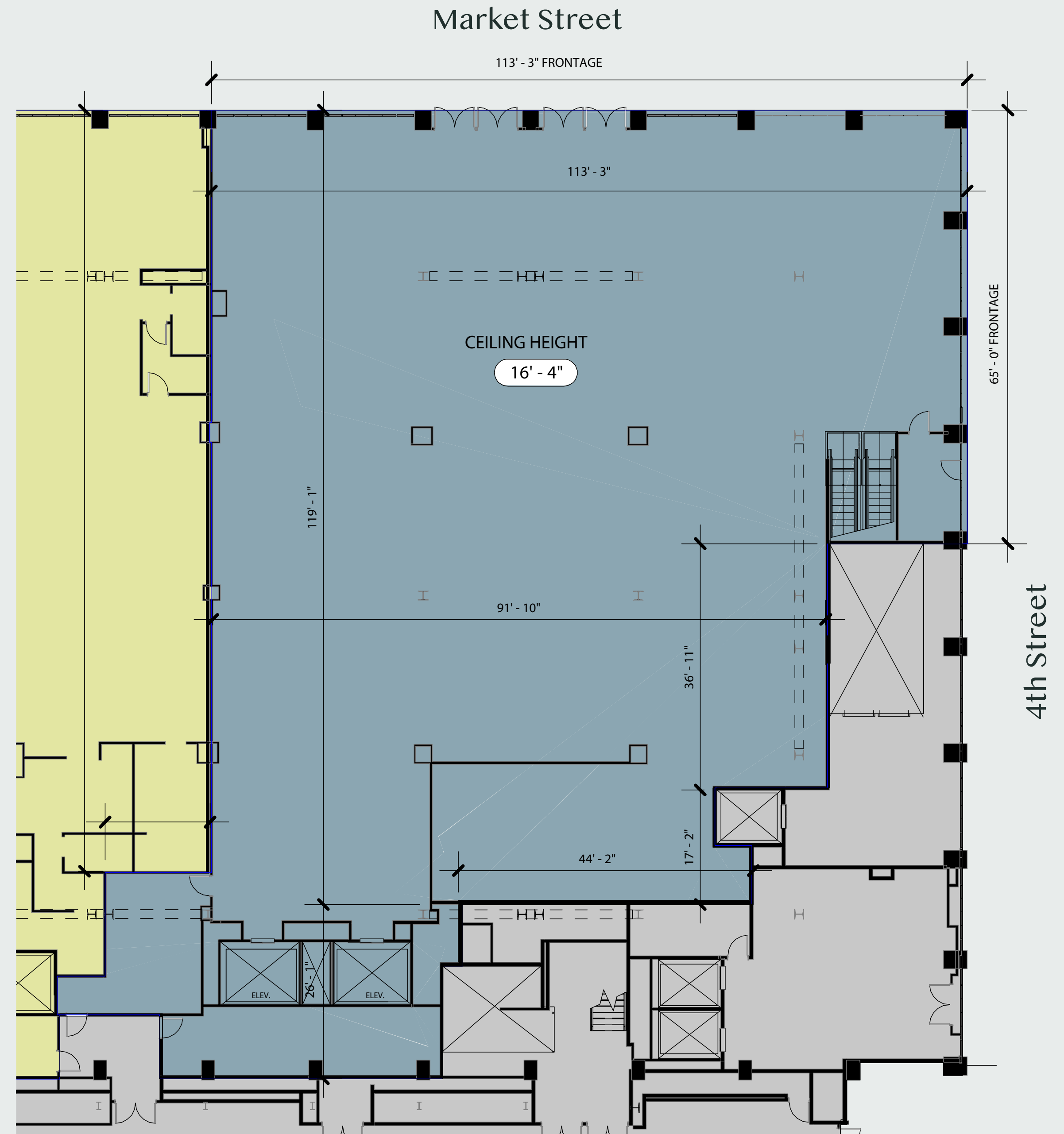
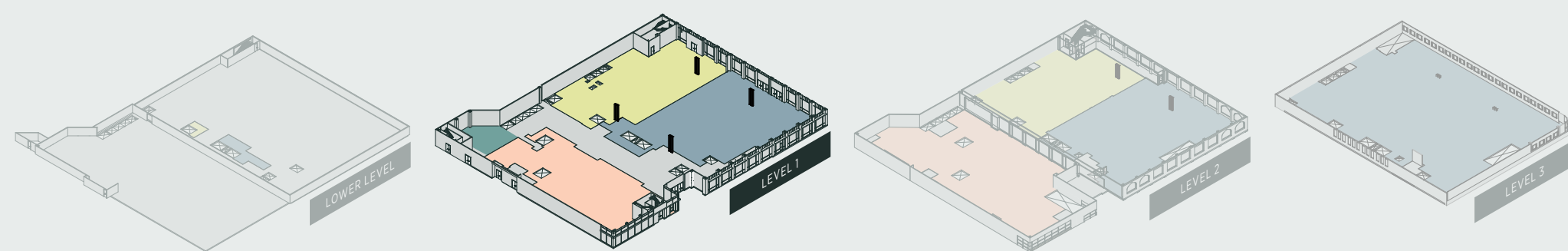

Beyond Boundaries

The City Advantage

801 Market Street | Level 2: 15,854 RSF

Total RSF: 56,838

Restrooms: Two separate restrooms located on the second level (2 stalls/1 urinal and 3 stalls)

Venting: TBC

Frontage: 113'-3" on Market Street / 65' on 4th Street

Ceiling heights:

Level 1 - EXPOSED @ 16'-4"

Level 2 - EXPOSED @ 14'-2"

Level 3 - EXPOSED @ 20'-2"

High visibility Market Street corner location

Steps from Powell Street BART station

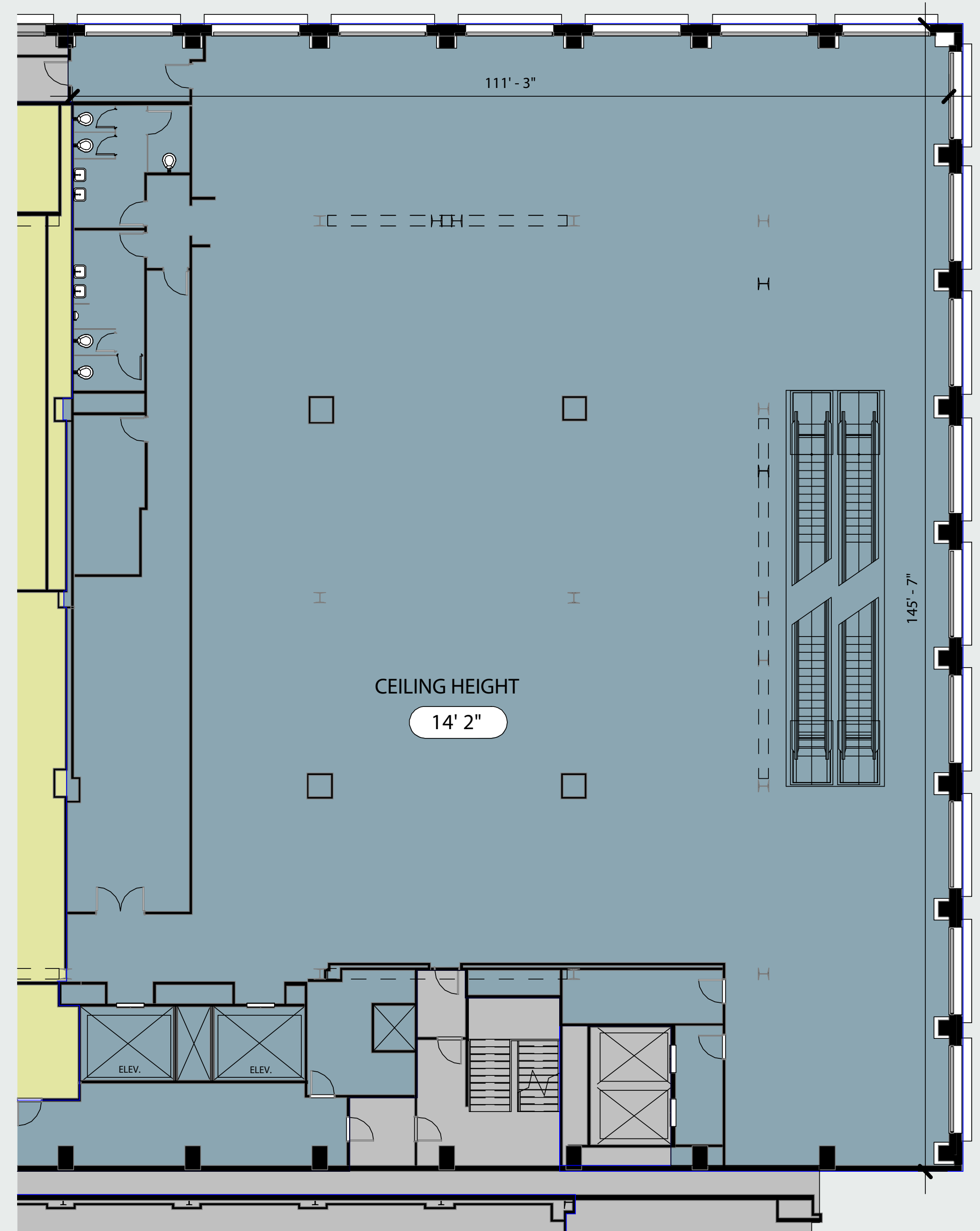
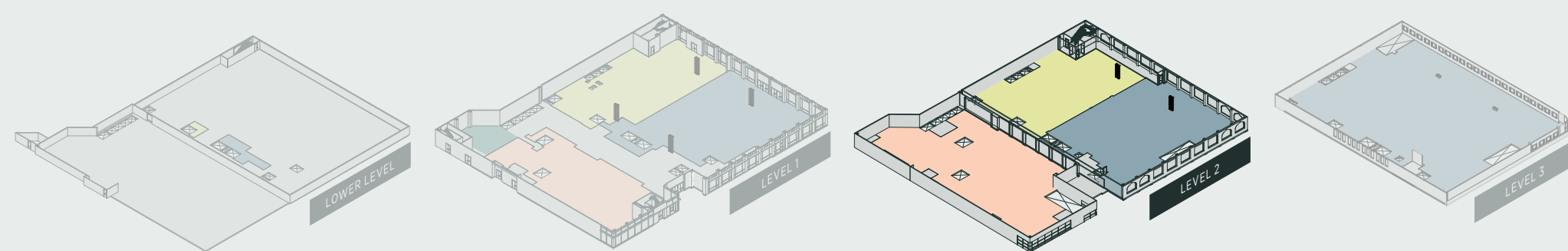

Beyond Boundaries

The City Advantage

801 Market Street | Level 3: 26,448 RSF

Total RSF: 56,838

Restrooms: Two separate restrooms located on the second level (2 stalls/1 urinal and 3 stalls)

Venting: TBC

Frontage: 113'-3" on Market Street / 65' on 4th Street

Ceiling heights:

Level 1 - EXPOSED @ 16'-4"

Level 2 - EXPOSED @ 14'-2"

Level 3 - EXPOSED @ 20'-2"

High visibility Market Street corner location

Steps from Powell Street BART station

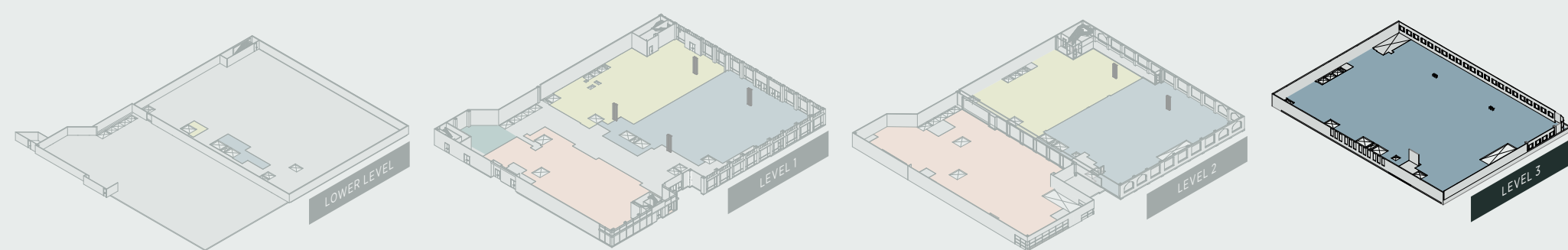
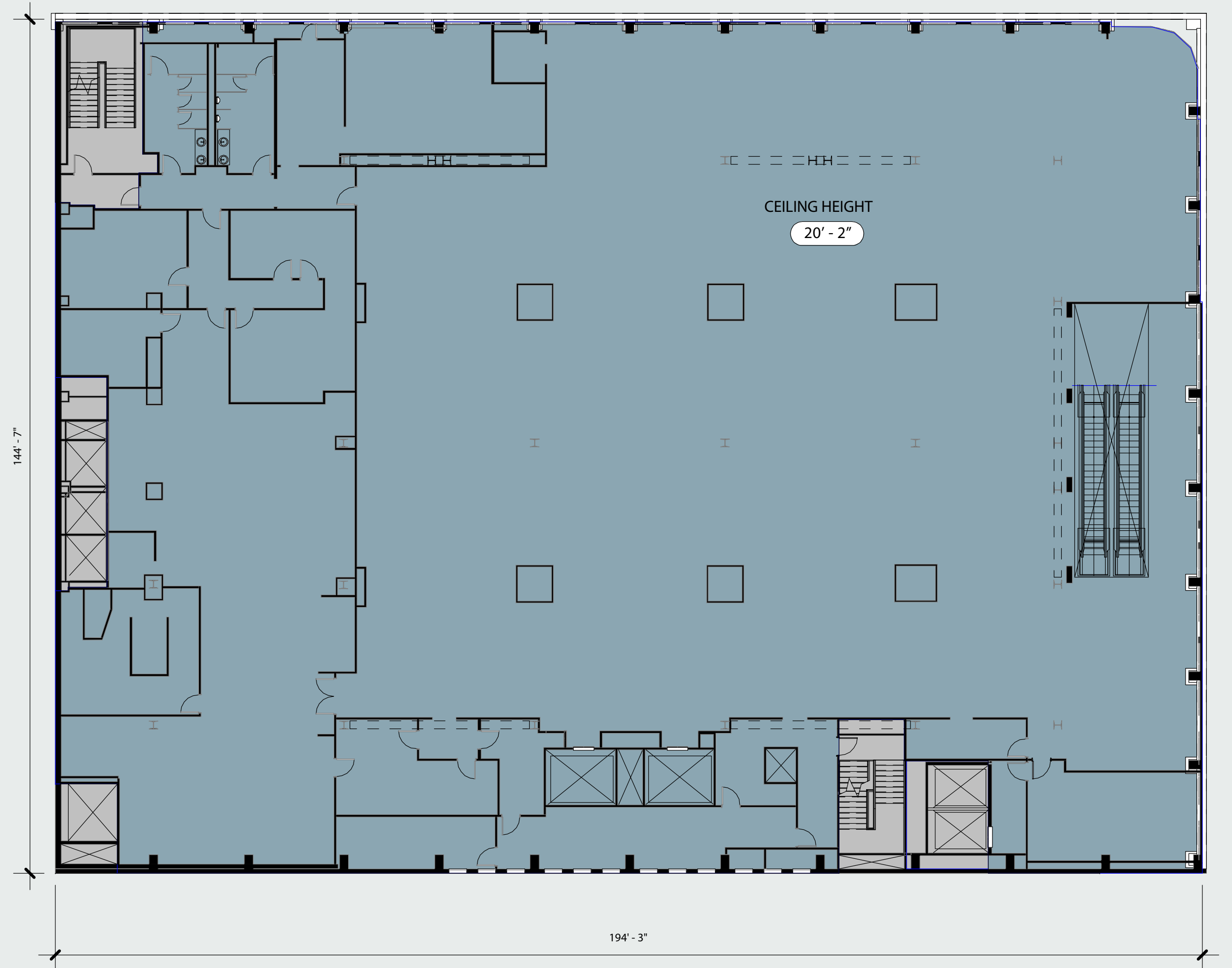

Beyond Boundaries

The City Advantage

801 Market Street | Lower Level: 1,040 RSF

Total RSF: 56,838

Restrooms: Two separate restrooms located on the second level (2 stalls/1 urinal and 3 stalls)

Venting: TBC

Frontage: 113'-3" on Market Street / 65' on 4th Street

Ceiling heights:

Level 1 - EXPOSED @ 16'-4"

Level 2 - EXPOSED @ 14'-2"

Level 3 - EXPOSED @ 20'-2"

High visibility Market Street corner location

Steps from Powell Street BART station

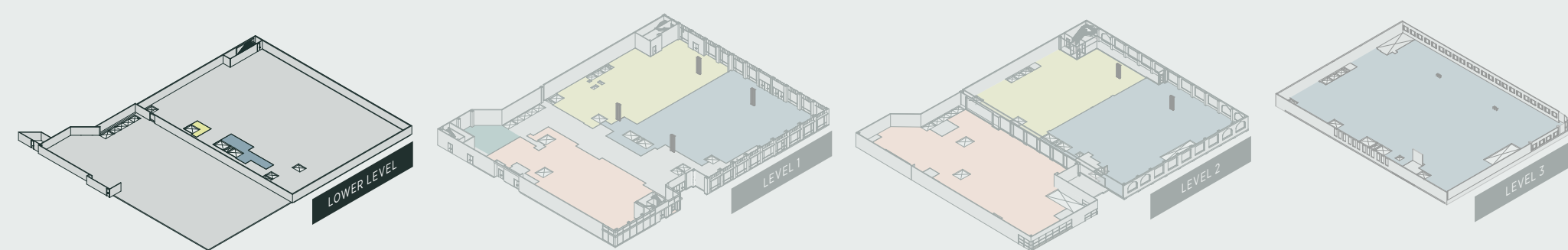
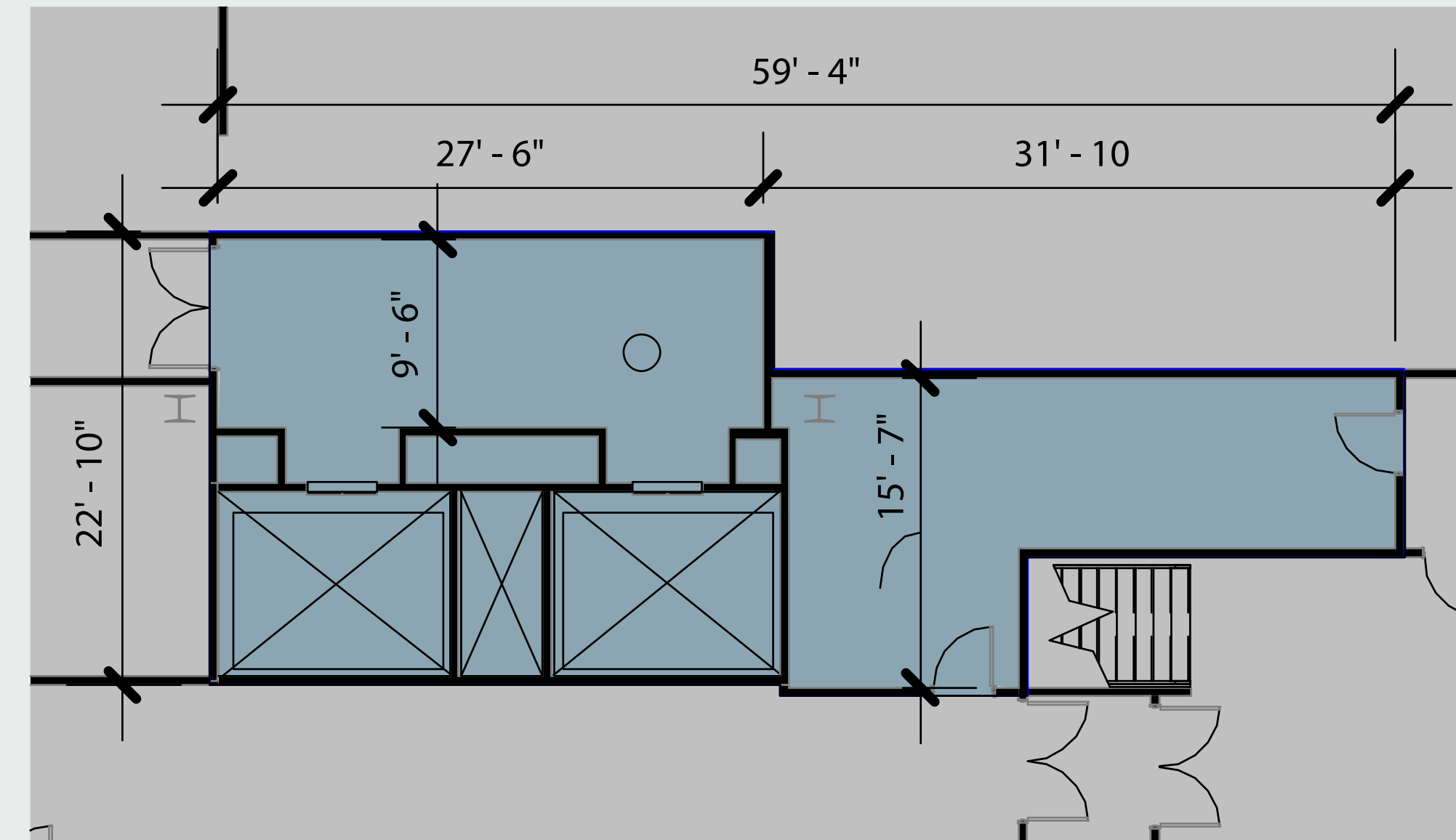

Beyond Boundaries

The City Advantage



The Container Store® Level 1: 12,518 RSF

Total RSF: 30,266

Restrooms: Two separate restrooms located on the second level

Venting: TBC

Frontage: 78' on 4th Street

Ceiling heights:

Level 1 - 12'-0" / EXPOSED @ 15'-4"

Level 2 - 8'-0" / EXPOSED @ 11'-8"

Next to the largest Trader Joe's in San Francisco

Steps from Powell Street BART station

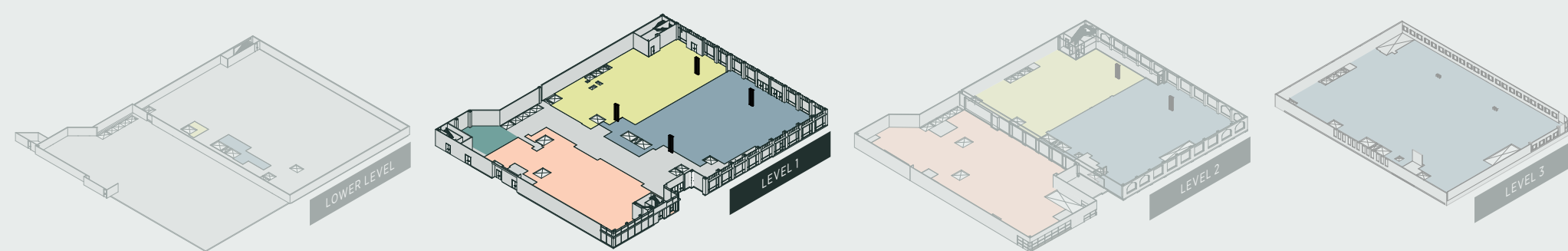
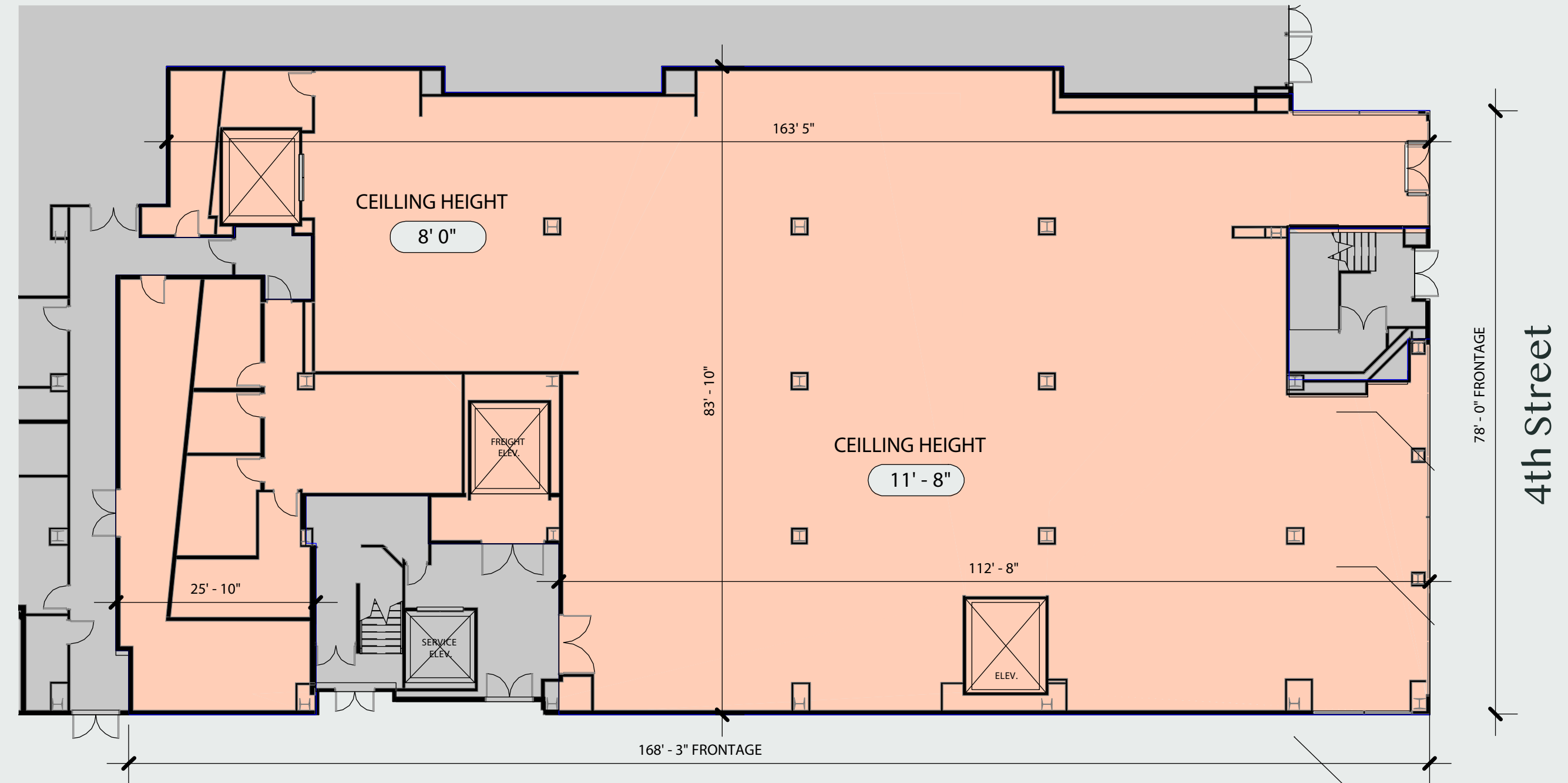

Beyond Boundaries

The City Advantage



The Container Store® Level 2: 17,748 RSF

Total RSF: 30,266

Restrooms: Two separate restrooms located on the second level

Venting: TBC

Frontage: 78' on 4th Street

Ceiling heights:

Level 1 - 12'-0" / EXPOSED @ 15'-4"

Level 2 - 8'-0" / EXPOSED @ 11'-8"

Next to the largest Trader Joe's in San Francisco

Steps from Powell Street BART station

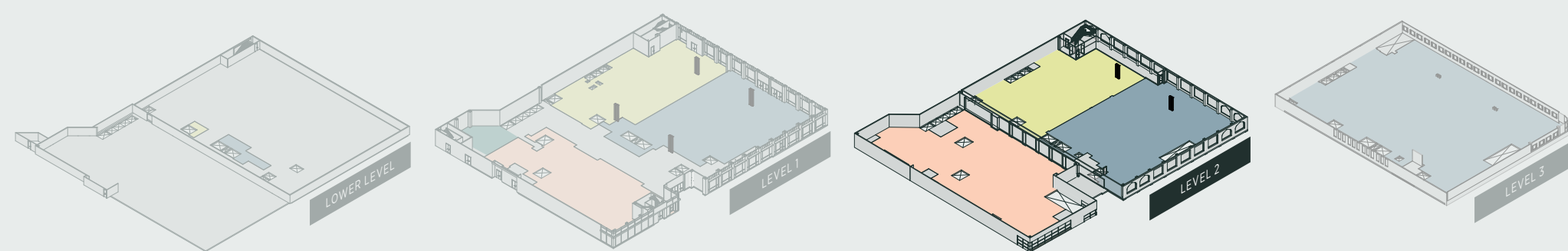
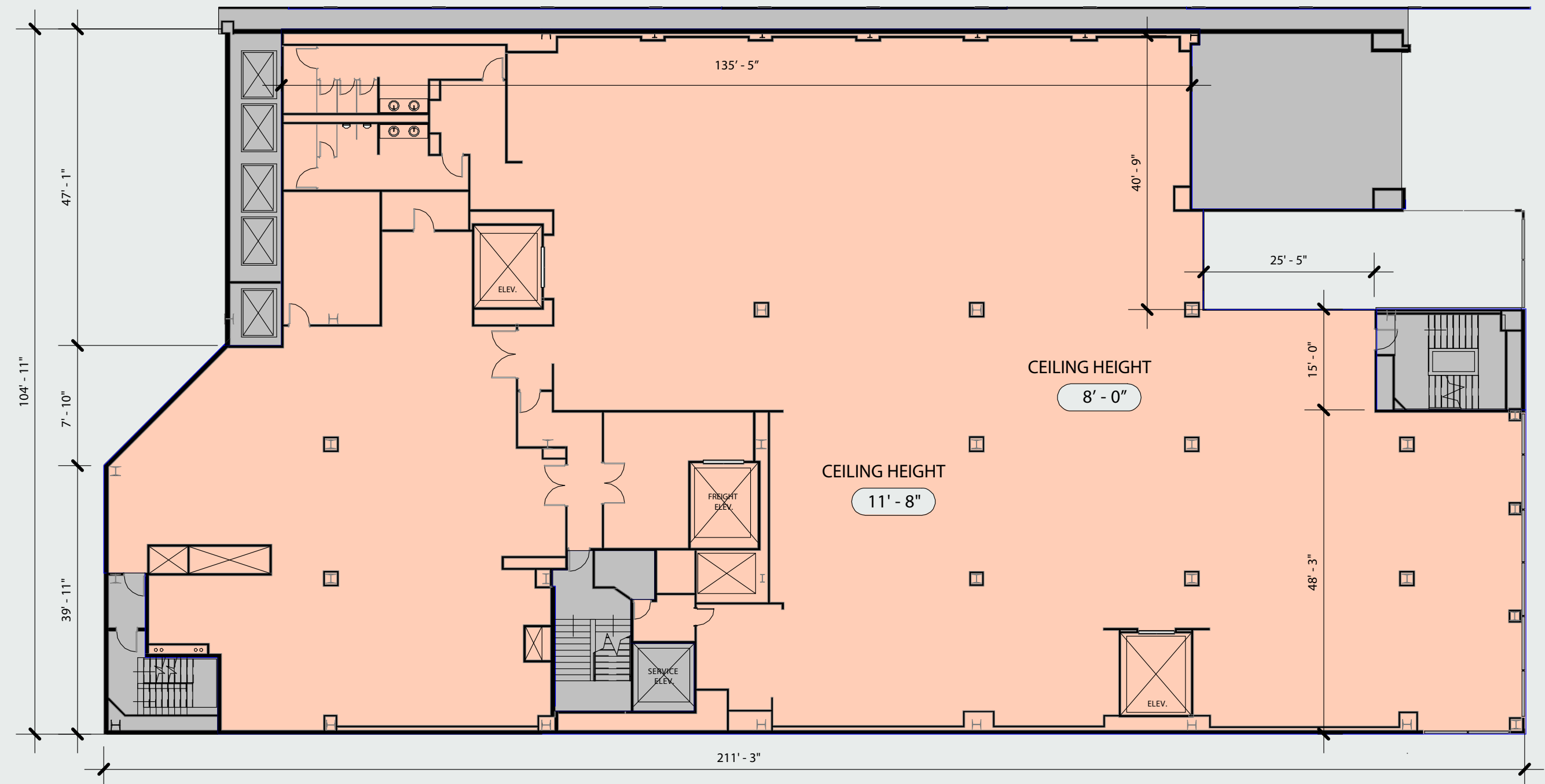

CBRE

+1 415 772 0306

Alex Sagues

Lic. 02055525
alex.sagues@cbre.com

Madeline Redmond

Lic. 02186119
madeline.redmond@cbre.com



© 2026 CBRE, Inc. All rights reserved. This information has been obtained from sources believed reliable but has not been verified for accuracy or completeness. You should conduct a careful, independent investigation of the property and verify all information. Any reliance on this information is solely at your own risk. CBRE and the CBRE logo are service marks of CBRE, Inc. All other marks displayed on this document are the property of their respective owners, and the use of such logos does not imply any affiliation with or endorsement of CBRE.